

DERBI

BALAS ROJAS

**WORKSHOP MANUAL
6 SPEED 50c.c ENGINE**





INTRODUCTION

DERBI - NACIONAL MOTOR, S.A., manufacturer of DERBI motorcycles and mopeds, has produced this manual with the aim of documenting and simplifying as much as possible the work you need to do to in dismantling and assembling the 6 speed 50 c.c. engine.

The intention is to provide as much assistance as possible to mechanics working for our brand's dealers and sub-dealers.

Due to its constant commitment to improving its products, **DERBI - NACIONAL MOTOR, S.A.** Sociedad Unipersonal reserves the right to introduce any modifications it deems fit, without prior warning.

All the information included in this manual is based on the latest data available at the time of its publication. The drawings and photographs in this manual are for reference purposes only, and may therefore not be exactly the same as the corresponding parts of the current model itself.

NACIONAL MOTOR, S.A.



CONTENTS

GENERAL INFORMATION	Page 4
ENGINE IDENTIFICATION NUMBER	Page 5
GENERAL TECHNICAL CHARACTERISTICS	Page 6
DISMANTLING THE CARBURETTOR	Page 10
DISMANTLING/REASSEMBLING THE REED VALVES	Page 14
DISMANTLING/REASSEMBLING THE COOLING SYSTEM	Page 16
DISMANTLING/REASSEMBLING THE OIL PUMP	Page 18
DISMANTLING/REASSEMBLING THE CYLINDER HEAD	Page 20
DISMANTLING/REASSEMBLING THE CYLINDER AND PISTON	Page 22
DISMANTLING/REASSEMBLING THE CLUTCH ASSEMBLY	Page 25
DISMANTLING/REASSEMBLING THE CRANKSHAFT AND GEAR CHANGE	Page 30
DISMANTLING THE ALTERNATOR MAGNETO	Page 38



GENERAL INFORMATION

SERVICE RULES

- Use original DERBI parts or parts and lubricants recommended by DERBI. Parts that do not comply with DERBI design specifications may damage the moped (engine and/or machine).
- Where indicated, use the special tools for this model.
- Always use new seals and gaskets when refitting.
- When tightening a series of nuts or bolts, start with the bolts with the larger diameter or start with the ones to the inside or centre of the part, and apply the specified tightening torque diagonally in two or three steps.
- Before removing any component from the engine, clean it carefully to prevent dirt from getting into the engine.
- Before refitting, lubricate all sliding surfaces.
- After reassembly, and before starting up the moped, check that all the parts are correctly fitted and working properly.



ENGINE IDENTIFICATION NUMBER

ENGINE NUMBER

The number is stamped onto the top of the left hand crank-case (next to the gearbox-clutch oil filler plug).

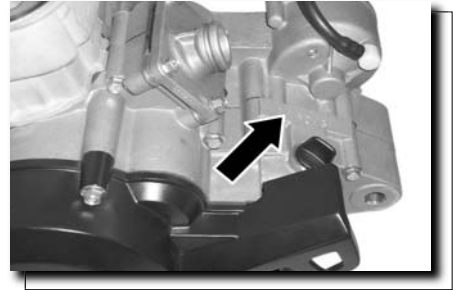

GENERAL TECHNICAL SPECIFICATIONS

ENGINE

Cycle	Two stroke
Diameter per stroke	39,88 x 40mm
Number of cylinders	One nickel and silicon carbide coated aluminium cylinder.
Total cylinder capacity	49cc
Maximum power	N/A
Compression ratio	11,5:1
Fuel	95/98 octane lead free petrol (min. 95 octane)
Inlet system	Reed valve direct to the crankcase
Starting system	Electronic/Kick-start (depending on model)
Lubrication system	Oil pump
Cooling system.	Liquid with pump, radiator and thermostat
Turn direction	Anticlockwise (looking at the magneto)

TRANSMISSION

Primary transmission	By straight gears												
Primary transmission ratio	3.7 (21/78)												
Clutch	Multi-disk in oil bath												
Gears	Constant mesh												
Gear ratios	<table border="0"> <tr> <td>1ª</td> <td>11/34</td> </tr> <tr> <td>2ª</td> <td>15/30</td> </tr> <tr> <td>3ª</td> <td>18/27</td> </tr> <tr> <td>4ª</td> <td>20/24</td> </tr> <tr> <td>5ª</td> <td>22/23</td> </tr> <tr> <td>6ª</td> <td>22/23</td> </tr> </table>	1ª	11/34	2ª	15/30	3ª	18/27	4ª	20/24	5ª	22/23	6ª	22/23
1ª	11/34												
2ª	15/30												
3ª	18/27												
4ª	20/24												
5ª	22/23												
6ª	22/23												
Transmission oil volume / Type	650c.c. SAE 10W40-PIGL-4												

GENERAL TECHNICAL SPECIFICATIONS

ELECTRICAL SYSTEM

Generator	Alternator magneto
Voltage /Generating power	12v / according to model
Ignition type	DIU
Ignition advance	1.2 mm. Before T.D.C.
Spark plug gap	See machine specifications table

MAINTENANCE PROGRAMME

CHECKS	KMS / MONTHS (whichever comes first)					
	1000 / 2	5000 / 12	10000 / 24	15000 / 36	20000 / 48	25000 / 60
Gearbox/clutch oil	Replace		Replace	Check	Replace	Check
Spark plug	Check	Replace	Replace	Replace	Replace	Replace
Carburettor	Adjust and clean	Adjust and clean	Adjust and clean	Adjust and clean	Adjust and clean	Adjust and clean
Cylinder/cylinder head/piston				Clean (every 15.000km)		
Complete piston (including segments)				Replace		
Air filter		Clean	Clean	Clean	Clean	Clean
Inlet reeds			Check		Check	
Engine coolant	Check	Check	Replace	Check	Replace	Check
Fuel and oil pipes		Check	Replace	Check	Replace	Check
Oil pump draught	Check		Check		Check	

SPARK PLUGS USED IN DERBI 50c.c. 6 SPEED ENGINES

See machine specifications table.

GENERAL TECHNICAL SPECIFICATIONS

TORQUE TIGHTENING TABLE

SECURING DEVICE DESCRIPTION	TIGHTENING TORQUE (N.m.)	TIGHTENING TORQUE (m•kg)
M1 4x125 spark plug-cylinder head securing device	20 ÷ 40	2 ÷ 4
M6x100 cylinder head cover-cylinder sec.dev.	8 ÷ 10	0,8 ÷ 1
M7x100 cylinder head nut sec.dev.	19 ÷ 22	1,9 ÷ 2,2
M1x100 magneto-crankshaft sec.dev.	35 ÷ 45	3,5 ÷ 4,5
M5x80 base plate-crankcase sec.dev.	2,5 ÷ 3,5 Sealed	0,25 ÷ 0,35 Sealed
M6x100 right cover-crankcase sec.dev.	8 ÷ 10	0,8 ÷ 1
M1 0x100 engine pinion-crankshaft sec.dev.	35 ÷ 45	3,5 ÷ 4,5
Kick-start lever bush – starter shaft sec.dev. M6x100	8 ÷ 10	0,8 ÷ 1
M6x100 crankcases sec.dev.	8 ÷ 10	0,8 ÷ 1
M3x0.5 reeds –support sec.dev.	1 ÷ 2	0,1 ÷ 0,2
M6x100 carburettor nozzle-crankcase sec.dev.	8 ÷ 10	0,8 ÷ 1
M5x80 oil pump-crankcase sec.dev.	3,5 ÷ 4,5	0,35 ÷ 0,45
M6x100 starter motor-crankcase sec.dev.	8 ÷ 10	0,8 ÷ 1
M6x100 Bendix cap -crankcase sec.dev.	8 ÷ 10	0,8 ÷ 1
M5x80 pump runner-pump shaft sec.dev.	3,5 ÷ 4,5	0,35 ÷ 0,45
M6x100 pump cover-crankcase sec.dev.	8 ÷ 10	0,8 ÷ 1
M1 4x150 thermistor –cylinder head sec.dev.	32 ÷ 38	3,2 ÷ 3,8
M4x70 thermostat—cylinder head cover sec.dev.	1 ÷ 1,5	0,1 ÷ 0,15
M1 2x150 clutch bell housing – primary shaft sec.dev.	35 ÷ 45	3,5 ÷ 4,5
M5x80 clutch spring – bell housing sec.dev.	3,5 ÷ 4,5	0,35 ÷ 0,45
M6x100 left cover-crankcase sec.dev.	2 ÷ 3,5	0,2 ÷ 0,35
M5x80 primary shaft bearing seal – crankcase sec.dev.	3,5 ÷ 4,5	0,35 ÷ 0,45
M5x80 (10.9) drum control head – drum sec.dev.	5 ÷ 7	0,5 ÷ 0,7
M1 0x150 oil drain screw – crankcase sec.dev.	15 ÷ 18	1,5 ÷ 1,8
M6x100 starter stop – crankcase sec.dev.	8 ÷ 10	0,8 ÷ 1
M1 0x100 counterweight pinion – counterweight shaft sec.dev.	35 ÷ 45	3,5 ÷ 4,5
Release lever-release shaft sec.dev. M6x100	8 ÷ 10	0,8 ÷ 1
M5x80 seal – change output pinion sec.dev.	3,5 ÷ 4,5 Sealed	0,35 ÷ 0,45 Sealed
M6x100 gear sec. lever -crankcase sec.dev.	8 ÷ 10 Sealed	0,8 ÷ 1 Sealed
M8x125 selector stop – crankcase sec.dev.	15 ÷ 19	1,5 ÷ 1,9
M5x80 oil pump cover - right cover sec.dev.	3,5 ÷ 4,5	0,35 ÷ 0,45
M6x100 gear lever – selector shaft sec.dev.	8 ÷ 10	0,8 ÷ 1
M1 0x100 (PA6) neutral indicator – crankcase sec.dev.	2,5 ÷ 3,5	0,25 ÷ 0,35

GENERAL TECHNICAL SPECIFICATIONS

SPECIAL USES

NUMBER	NAME	REFERENCE
1	Crankshaft oil seal fitting tool	00H05400451
2	Starter shaft oil seal fitting tool	00H05400581
3	Selector shaft oil seal fitting tool	00H05401561
4	Clutch bell housing securing tool	00H05300041
5	Primary shaft needle bush fitting tool	00H05600241
6	Engine opening pusher	00H05300151
7	GPR secondary shaft oil seal guide pivot	00H05600351
8	Alternator magneto extractor	00F05300021
9	Alternator magneto turn locker	00G05300011
10	Senda engine pinion	00D05310091
11	GPR engine pinion	Herramienta standard
12	Water pump exterior oil seal	00H05600421
13	Water pump interior oil seal	00H05600431
14	Engine pinion fastening tool	00H05100101
15	Counterweight shaft cage	00H05401451
16	Counterweight shaft oil seal	00H05400461
17	Water pump shaft guide pivot	00H05601261
18	Crankshaft journal oil seal guide pivot	00H05301841

DISMANTLING/REASSEMBLING THE CARBURETTOR

CARBURETTOR

- Loosen the clamps securing the carburettor to the inlet nozzle and the air filter nozzle. Disconnect the fuel, oil and fuel tap depressor pipes, and extract the carburettor.



- Loosen the carburettor cover screw and dismantle it together with the throttle cable assembly, gas valve and tapered dosage needle(1).

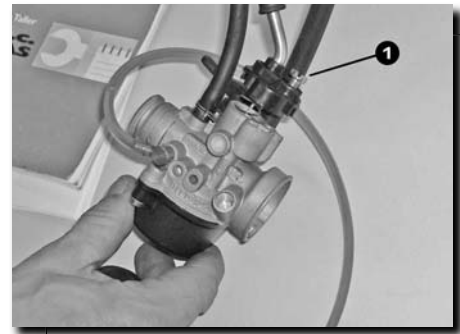

- Compress the gas valve return spring against the cover and extract the throttle cable terminal through the gas valve channel.

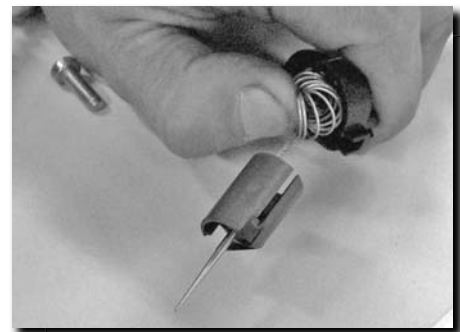

- Dismantle the cold start (choke) system piston valve securing clamp and extract the assembly (1).

- Before removing the idling circuit air quantity regulating screw ("compensator"), check its position by counting the number of turns needed to screw it right in (without forcing).

Make a note of this measurement and then unscrew and remove it. - (In case of doubt, consult the machine specifications table to determine the factory set position for this screw).

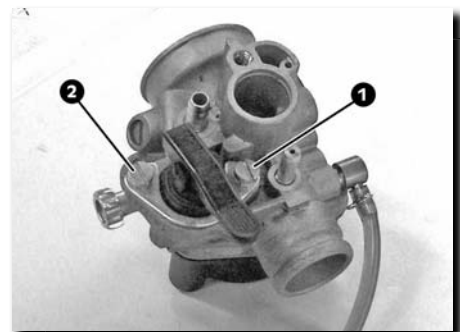

DISMANTLING/REASSEMBLING THE CARBURETTOR

- Extract the screws from the carburettor bowl and extract the bowl itself, thereby gaining access to the bores: the maximum(1), minimum(2) and cold start bores, as well as the float and its needle valve.

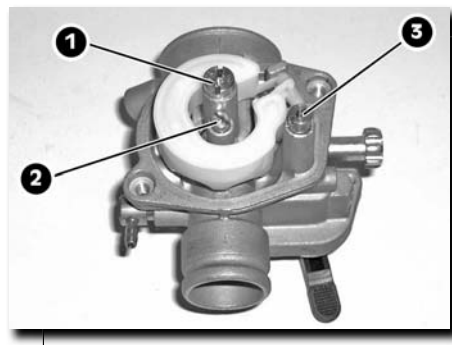

REASSEMBLING THE CARBURETTOR

- Clean all the components of the carburettor with solvent (take care not to damage the carburettor bowl gasket or the cold start valve O-ring).

- With the aid of compressed air, blow meticulously through all of the orifices through which air, oil and fuel pass.

- With the aid of scales, check the weight of the float. This is engraved on it (3.5 grams). If it exceeds this weight, renew it.

- Check that the tapered needle controlling the flow of petrol to the bowl, together with the spring on its stem connecting it to the float, are in good condition. Should this not be the case, renew them.

- Check the condition of the cold start system piston valve. In the event of the vulcanised closing seat or the metal body of the piston being damaged (scratches and/or corrosion that exceed 25% of its total area), renew it.

- Check the size of the bores based on the numbers etched onto them. Fit suitable ones (see adjustments table). Failure to do so will result in the performance of the engine being affected.

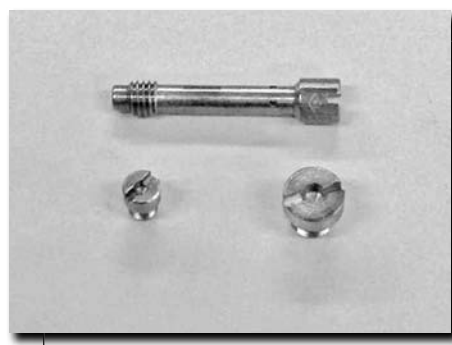
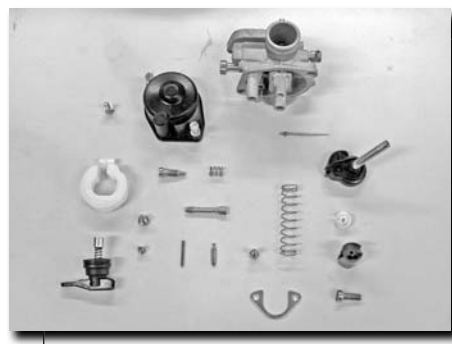

DISMANTLING/REASSEMBLING THE CARBURETTOR

- Check the position of the tapered dosing needle.
- Moving the circlip on the needle upwards results in a leaner mixture, and moving it downwards results in a richer mixture. This allows adjustments to be made for extreme climatic conditions.
- Renew the tapered dosing needle if damage is visible on its circumference.
- Check for the absence of scratches on the minimum circuit air regulator screw cone. These would affect its performance.

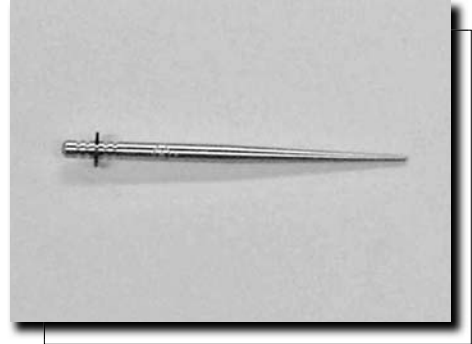

- Check for the absence of scratches on the sliding valve. In the event of these exceeding 25% of its total area, renew it.



- Be sure to install one with the same characteristics (see markings on its base).



DISMANTLING/REASSEMBLING THE CARBURETTOR

- Completely reassemble the carburettor. Refit the carburettor to the engine, making sure to connect the fuel, oil and fuel tap depressor activation pipes properly.

- Check that the idling circuit air quantity regulating screw ("compensator") is in a similar position to that before dismantling (in case of doubt, consult the machine specifications table to determine the factory set position).

- Check that the throttle control run is correct and is not blocked or hardened at any point.

- Set the free play adjustment of the throttle cable sleeve tensioner on the throttle twist-grip to give a free play of 3 to 5 mm.

- Extract the foam air filter, wash it in soapy water, then wring it out and dry it completely. Next, soak it in special oil for filters and refit it.

- Then adjust idle speed, using the following procedure:

1. Start the engine.

2. Screw in the screw regulating the sliding valve at rest position until the engine is about to stall.

3. Then slowly screw in or unscrew the screw regulating the sliding valve at rest position until an idle speed of 1600 ± 200 rpm is achieved (with the help of an external rev-counter).

4. Turn the throttle twist-grip sharply to cause a rapid increase in engine revs, and check that it accelerates and decelerates smoothly and quickly, without missing. Should this not be the case, adjust the position of the minimum air regulating screw (AS) $\frac{1}{4}$ of a turn and go back to point 3. Screwing in the AS will obtain a richer mixture (with more petrol), while unscrewing the AS will lead to a leaner mixture (less petrol).

DISMANTLING/REASSEMBLING THE REED VALVE

DISMANTLING THE REED VALVE

- Remove the carburettor from the engine.
- Extract the inlet nozzle closing bolts and the inlet nozzle. The reed valve can then be accessed and extracted



- Check that there are no cracks, distortions or breakages on the reed petals. If there are, renew them.



- Remove the securing screws from the height limiter and from the inlet valve petals and check that there are no cracks in the petals' securing base. If there are, renew the reeds.

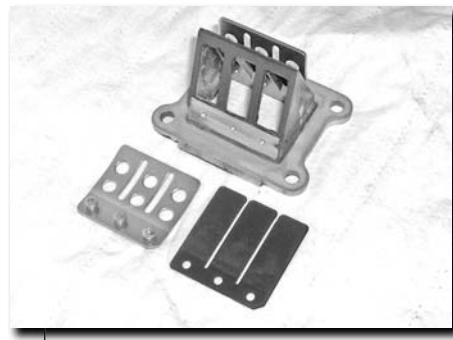

REFITTING THE REED VALVE

- To refit the reed valve, proceed in the reverse order to dismantling, paying special attention to the correct positioning of the height limiter and the reed (with the bevels matching). The elimination of the height limiter and the type of reed used will modify the performance of the engine and may make it less reliable.

- Check the reed cage O-ring and replace it if damaged. Fit a new seal.

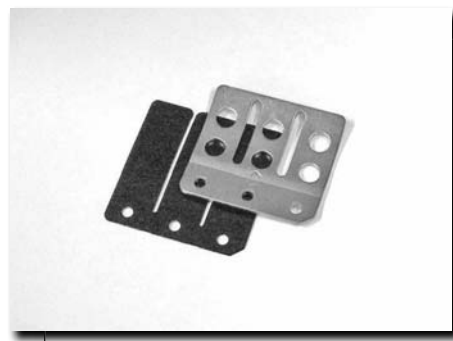

DISMANTLING/REASSEMBLING THE REED VALVE

DISMANTLING THE COOLING SYSTEM

- Completely drain the coolant from the engine by detaching the hoses connecting the pump to the radiator.
- Drain the engine oil and extract the transmission cover.
- Remove the bolts from the water pump cover and extract it.



- Loosen the water pump runner securing nut and extract the latter by unscrewing it.

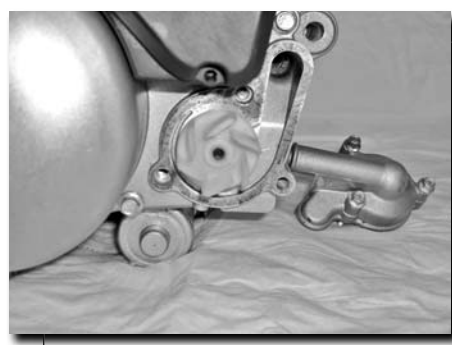

- Extract the circlip, top washer, pump driving pinion, its key and the bottom washer. Then gently tap the shaft from the inside outwards, pulling with it the two seals.

- Change the water seals at the first sign of coolant or oil leaking from the breather bore. Also renew the shaft if it shows signs of wear at the circumference where the seals are positioned.

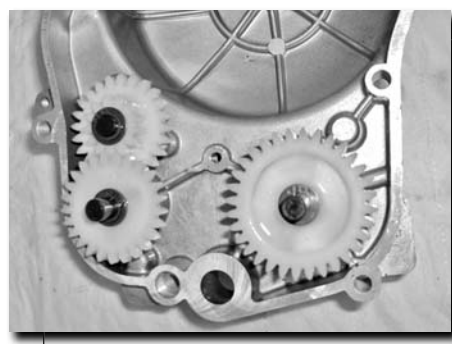

REFITTING THE COOLING SYSTEM

- Fit the circlip (1) onto the shaft stem (2), inserting it into the cover from the outside with the 8.3 x 14 x 1 washer (3) under the circlip.

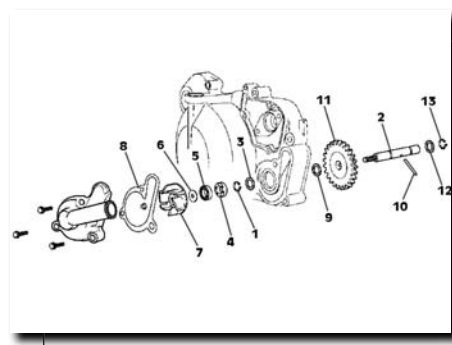

DISMANTLING/REASSEMBLING THE COOLING SYSTEM

- Use tool number 13 (see special tools list) to insert the inner oil seal (4) with the spring downwards. Use tool number 12 to fit the top oil seal (5) with the spring upwards. Both seals should be lightly greased.

- Fit the 5.25 x 15 x 1 washer (6), the pump runner (7) and the securing nut (8). Tighten to a torque of 0.35-0.45 m.kg.

- Through the inside of the cover fit the 8.3 x 14 x 1 washer (9), the key (10), the pump driving pinion (11), the 8.3 x 14 x 1 washer (12) and the circlip (13).

- Fit the transmission cover with a new gasket and refill the engine crankcase with 650 c.c. of SAE 10W40 API GL-4 type oil.

- Fit a new water pump cover gasket.

- **The cooling system should then be refilled and purged according to the following procedure:**

1. Prepare an external feed tank with -18°C freezing point coolant positioned at a height of approximately 2m from the ground, with the aim of filling the cooling system from the expansion tank.

2. Start up the engine and keep it ticking over.

3. Open the feed tank tap and let the coolant flow freely until it reaches the minimum level in the cooling system expansion tank.
Close the tap.

4. Close the expansion tank valve cap.
Warm up the engine until the thermostat opens.

5. Check that the body of the radiator warms up. If it fails to do so, this is an indication that the thermostat has not opened or that there are air locks inside the cooling system circuit.

6. Turn off the engine and allow to cool.



DISMANTLING/REASSEMBLING THE COOLING SYSTEM

7. Replenish the expansion tank with coolant until the minimum level is reached in the expansion tank (on warming up, the level will rise due to expansion in the circuit).

8. Check the electric circuit of the overheating warning indicator on the instrument panel, by disconnecting the temperature sensor connector and connecting its terminal to earth using a length of wire, and then turning on the ignition. The instrument panel indicator light should light up.

9. To check the cylinder head temperature sensor, as well as the fan activating thermo-contact (only in the versions where this is fitted) submerge their active part in a container filled with water and heat this up. Connect a multi-meter set to read resistances between its metal body and connection terminal and check that as the water temperature rises, the sensor's resistance value decreases. If this is not the case, renew the sensor.

SENSOR	ON	OFF
CYLINDER HEAD COOLANT TEMP.	$124 \pm 3^{\circ}\text{C}$	$114 \pm 3^{\circ}\text{C}$
ELECTRO-FAN THERMO-CONTACT	$97 \pm 3^{\circ}\text{C}$	$85 \pm 3^{\circ}\text{C}$

- The thermostat should be suspended submerged in a container of water without touching the container, and the water heated up. Use a thermometer to check when the thermostat begins to open and when it stops opening (completely open).

OPENING STARTS	TRAVEL
$60^{\circ}\text{C} \pm 2^{\circ}\text{C}$	$3.5 \div 5 \text{ A } 70^{\circ}\text{C} \pm 2^{\circ}\text{C}$

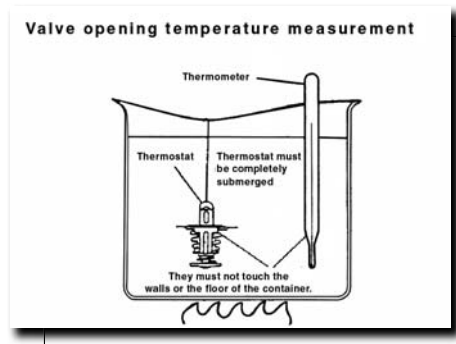
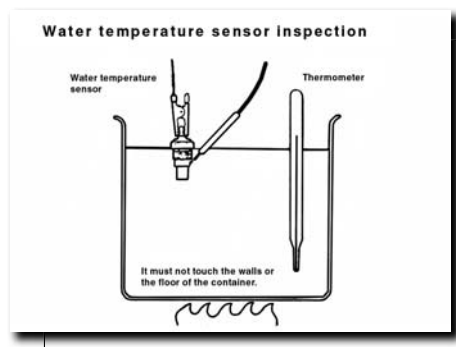

DISMANTLING/REFITTING OIL PUMP

DISMANTLING THE OIL PUMP

- Remove the inspection cover situated on the clutch half-housing.
- Free the securing clamps on the pump input and output oil pipes. Plug the input pipe to prevent the oil tank from draining.



- Dismantle the pump control cable, freeing it first from the control cam and then from the sleeve stop on the clutch half-housing.



- Remove the two Allen screws securing the pump to the clutch half-housing and extract the pump. Turn the pump shaft manually and check that it turns smoothly.
- Check the condition of the O-ring and the shaft oil seal. Renew them if they are damaged.
- The oil pump is an essential unit for the proper safe functioning of the engine. In the event of faults, it should be renewed not dismantled.

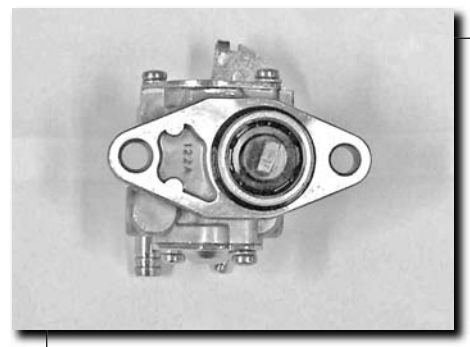

REFITTING THE OIL PUMP

- Refit by carrying out the removal procedure in reverse up to this point.
- Take special care to ensure that the shaft movement transmission notches mesh correctly with the gearing on the clutch half-housing.

DISMANTLING/REFITTING OIL PUMP

- The oil pump must then be bled in accordance with the following procedure:

- 1. Fit the pipe carrying oil from the tank to the pump.**
- 2. With the aid of a syringe, fill the pump output pipe with synthetic 2-stroke API TC SAE 30 oil, and fit it between the pump and the carburettor.**
- 3. Extract the pump bleed screw.**
- 4. It provides the carburettor with an independent supply of petrol and synthetic 2-stroke API TC SAE 30 oil at a proportion of 2%.**
- 5. Start up the engine and keep it ticking over. Move the pump cam manually as far as it will go, and hold it there until the oil is seen to flow out of the pump bleed hole without bubbles.**
- 6. Fit the pump bleed screw and check that the oil flows freely out of the end of the output pipe that is connected to the carburettor.**
- 7. Stop the engine and eliminate the supply with mixture. Restore the petrol supply from the tank.**
- 8. Fit the control cable and adjust the slack until the arrow on the control cam lines up with the mark on the pump (throttle twist-grip completely closed).**
- 9. Replenish the reserve tank with oil up to the maximum level.**

DIMANTLING/REASSEMBLING THE CYLINDER HEAD

DISMANTLING THE CYLINDER HEAD

- Drain the coolant by removing the hose fitted to the water pump.
- Position a tray to collect it.
- Extract the hose between the cylinder head and the radiator.
- Disconnect the temperature sensor connector.
- Disconnect the spark plug HT cable (connector cap), and extract the spark plug.
- First loosen diagonally and then remove the five M6 bolts and remove the cylinder head cover.



- Loosen the four M7 cylinder head nuts diagonally and extract them.



DIMANTLING/REASSEMBLING THE CYLINDER HEAD

- Extract the cylinder head and its gasket on the cylinder.
- Clean off gasket debris and carbonisation without scratching or wearing down the surfaces.

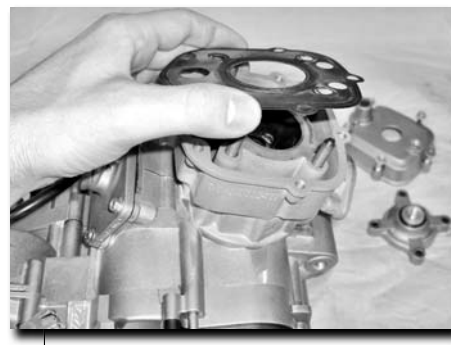

- With the aid of a straight ruler and a thickness calliper, check the mating surfaces – both on the cylinder head and the cylinder - for warping.

Maximum warping:
0,05 mm.

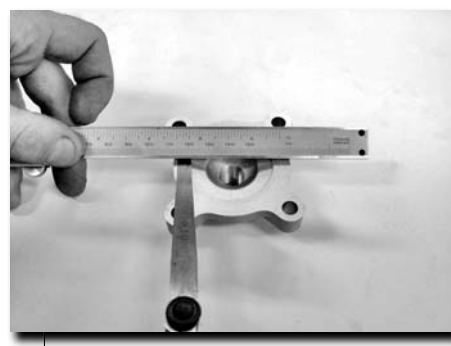

REFITTING THE CYLINDER HEAD

- Reverse the steps indicated up to this point.
- Fit a new head gasket, ensuring that the mating surfaces
 - both on the cylinder head and the top of the cylinder
 - are properly cleaned. Do not apply any kind of sealant.
- Fit the cylinder head and tighten the M7 nuts provisionally prior to applying a diagonal tightening torque of 1.9
 - 2.2 m.kg.
- Fit the cylinder head cover and tighten the five M6 bolts provisionally prior to applying a diagonal tightening torque of 0.8 – 1 m.kg.
- Correctly refit the pipes between the cylinder head and the radiator.
- Fit a new spark plug.
- Reconnect the temperature sensor and the spark plug cable.
- Refill the cooling system with -18°C freezing point coolant, and bleed the system.

DISMANTLING/REASSEMBLING THE CYLINDER AND PISTON

DISMANTLING THE CYLINDER AND PISTON

- Drain the coolant from the engine.
- Remove the cylinder head cover and the cylinder head.
- Extract the cylinder by pulling it upwards.
- Remove the cylinder bottom gasket.
- Inset a clean cloth into the crankcase opening to prevent objects from accidentally falling inside.
- Extract the gudgeon pin fastening circlips, and then remove the gudgeon pin, the piston and the connecting rod big end bearing.
- If the gudgeon pin needs to be pushed to extract it, hold the connecting rod firmly and on the opposite side to the pushing direction, with the aim of avoiding possible damage or distortion of the connecting rod.
- Clean all surfaces and gently eliminate gasket debris and carbon deposits (taking care not to scratch the piston circumference).
- Check the condition of the connecting rod big end visually. If any damage is visible on the contact surface with the needle bearings, renew it.
- Make a visual examination of the condition of the big end needle bearing. If any damage is visible on the needles or cracks in the cage, renew the bearing.
- Extract the piston rings by opening them at their points and lifting them out away from their points.

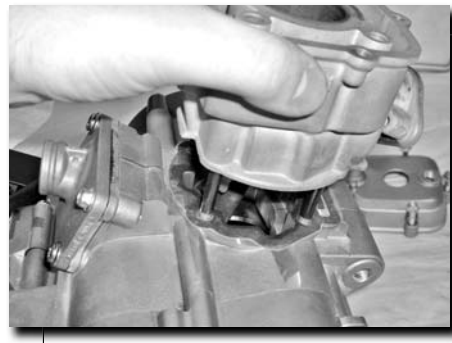

DISMANTLING/REASSEMBLING THE CYLINDER AND PISTON

CHECKING THE CYLINDER AND PISTON

- Check the ring point gaps by inserting them lined up into the cylinder and checking the gap with a thickness calliper.

Minimum limit:
0,15 mm.

Maximum limit:
0,35 mm.



- Check the degree of cylinder wear with the aid of an alexometer. Pre-calibrate it based on the dimensions set out in the attached cylinder family table.

- Piston.

- Check the piston on two axis and at three height levels.

Service limit:
0,05 mm.

Family	ØPiston±0.0025mm	ØCylinder±0.0025mm	Play
A	39.850	39.890	0.035 ÷ 0.045
B	39.855	39.895	
C	39.860	39.900	
D	39.865	39.905	

- Check the diameter of the piston on the transverse axis to the gudgeon pin at a distance of 15mm from the bottom of the piston base.

Service limit:
0,01 mm.

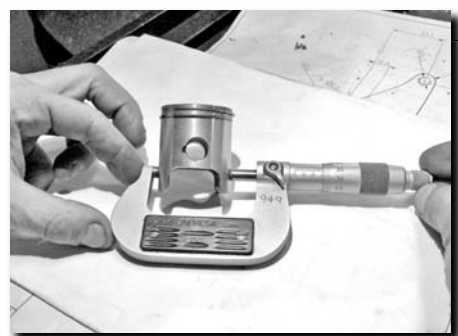

DISMANTLING/REASSEMBLING THE CYLINDER AND PISTON

REFITTING THE CYLINDER AND PISTON

- Fit the piston rings.
- Fit a new cylinder base gasket.
- Fit the needle bearing cage, piston, gudgeon pin and circlips, lubricating these first with synthetic API TC SAE 30 oil. Pay attention to the piston position mark (the arrow must point towards the exhaust).
- Make sure they have entered completely into their channel.
- Compress the piston rings inside their channels, taking care that they do not lie over the fixed stops.



- Lubricate the inside of the cylinder as well as the piston and its rings.
- Fit the cylinder, checking that the piston slides smoothly within it.



- Fit a new cylinder head gasket and refit the cylinder head and cylinder head cover.
- Fit a new spark plug.
- Reconnect the temperature sensor and the spark plug cable.
- Refill the cooling system with -18°C freezing point coolant, and bleed the system.

DISMANTLING/REASSEMBLING THE CLUTCH ASSEMBLY

DISMANTLING THE CLUTCH ASSEMBLY

- Drain the coolant from the engine.
- Drain the oil from the transmission by removing the two plugs (clutch half-casing and crankcase base).
- Extract the oil pump assembly together with its pipes and control cable.

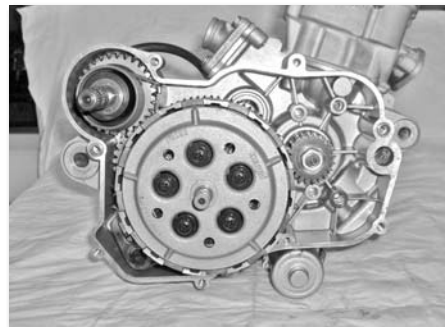

- Extract the kick-start lever (on the versions where it is fitted).

- Extract the bolts from the clutch half-casing and remove it. This will provide access to the primary transmission elements, clutch, starter system and selector shaft.



- Remove the set of locking screws and springs on the clutch push plate and remove the plate.

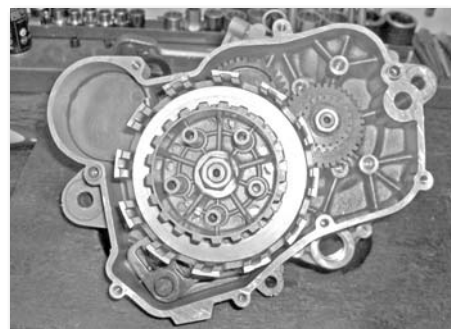

- Extract the set of driven discs and driving disks.
- Free the clutch bell housing nut seal.
- Lock the clutch bell housing with tool number 4 and remove the nut.

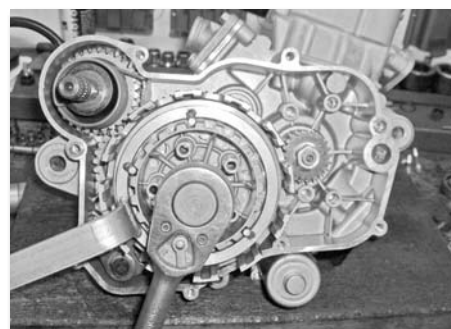

DISMANTLING/REASSEMBLING THE CLUTCH ASSEMBLY

- Extract the driven bell housing.
- Pay attention to the centre bush and set of washers.
- Extract the driving bell housing.
- To untighten the balance shaft gear securing nut, on those engines where it is fitted (1), as well as for the engine pinion nut (2), insert tool number 14.

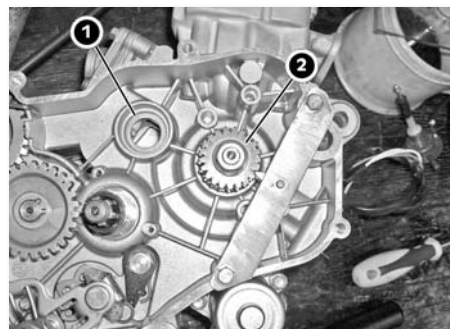

- Engine pinion extraction tool:
Models with balance shaft: Standard Tool.
Models without balance shaft: Tool number 10.



- Check the thickness of the clutch lining on each disk, with the aid of a thickness calliper.
Service limit: 3.8 mm.



- Renew the disk if there is a loss of lining, thermal fatigue (discoloration), distortion, or if the external notching is damaged.
- Check the clutch disks for warping.

Service limit:
0,15 mm.



DISMANTLING/REASSEMBLING THE CLUTCH ASSEMBLY

CHECKING THE PRIMARY TRANSMISSION

- Make a visible check of the teeth. If there are thermal fatigue marks (discoloration), loss of surface hardness covering, or uneven wear to the teeth (points), replace the damaged components.

- Check the driving clutch bell housing:

1. Notch slots.
2. Clearance of the rivets and silent-blocks joining with the gearing.
3. Condition of the turning bush on the primary shaft.

- If severe damage is seen, renew it.

- Check that there are no scratches or grooves on the mating surface of the disks. If there are, replace the affected element.

- Check the push plate assembly and its axial needle bearing, and renew any damaged elements.

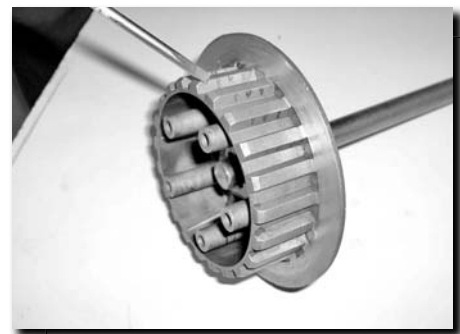

DISMANTLING/REASSEMBLING THE CLUTCH ASSEMBLY

- Check the free length of the spring, and renew it if it exceeds the service limit.

Service limit:
31 mm.

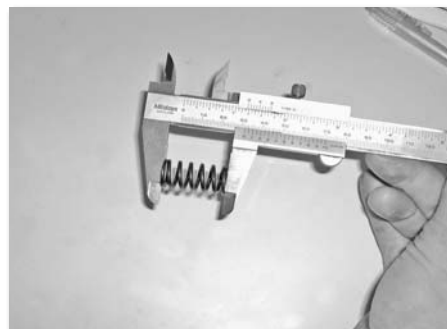

- With the aid of a set square, check the degree of spring parallelism. Renew it in the event of distortion.

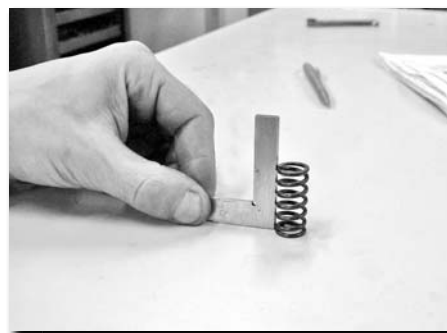

REFITTING THE CLUTCH

- Refit in the opposite order to dismantling.
- Remember to fit the clutch bell housing (driving and driven) support washers.
- Take into account the following steps when fitting the balance shaft in those engines where it is fitted (poor fitting will result in a high level of vibration).
- Inserting the balance shaft: Align the mark (1) on the engine shaft with the mark (2) on the balance shaft drift.

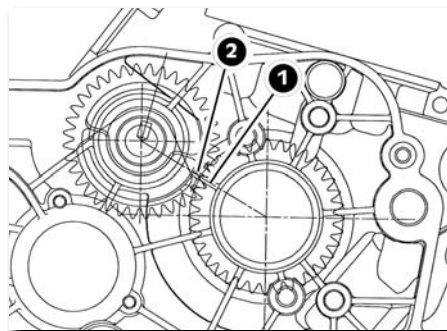

DISMANTLING/REASSEMBLING THE CLUTCH ASSEMBLY

- Fit the primary shaft washers and the driving and driven clutch bell housings.

- Be sure to apply the specified tightening torque, both for the crankshaft gearing nut (1) (3.5 - 4.5 m.kg) and the clutch housing nut (2) (3.5

- 4.5 m.kg) (remember to fit a new tab washer (3) and to flatten it against one of the nut's sides).

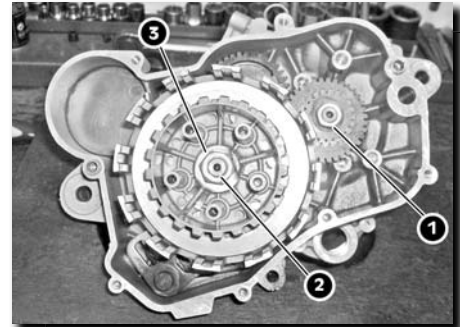

- Fit the clutch disks in such a way that the mark on them faces outwards.

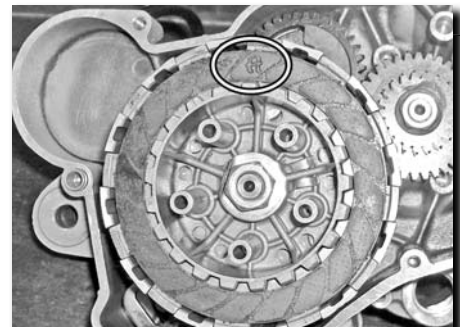

- Fit the clutch pressure plate in such a way that the "DERBI" logo fits into the slot incorporated into the driven clutch drum.

- Be sure to apply the required tightening torque for the clutch pressure plate securing bolts and their springs (0.35- 0.45 m.kg).

- Fit a new clutch cover gasket.

- Fit new sealing washers on the oil drain bolts (crankcase and clutch half-casing) and tighten them.

- Fill the gearbox – clutch assembly with 650 c.c. of SAE 10W40 oil.

- Fit the control cable to the clutch half-casing cam and check the free play on the left hand handlebar lever (minimum free play approx.: 5 mm.).

- Start up the engine and make a quick test of gear change and clutch function.



DISMANTLING/REASSEMBLING THE CRANKSHAFT AND GEAR CHANGE

DISMANTLING THE CRANKSHAFT AND GEAR CHANGE

- Dismantle the thermodynamic unit (cylinder head, cylinder and piston).
- Dismantle the alternator magneto (see electrical system).
- Completely dismantle the primary transmission assembly, including the starter system, gear selector shaft and balance shaft pinion.
- Extract the balance shaft from the left hand side of the engine.
- First loosen and then completely extract all the crankcase securing bolts (twelve 6x100 bolts), from the left hand side of the engine.



- Extract the intermediate starter gearing housed on the end of the secondary gear change shaft, together with the speed fixing resend (1), and its "star" (2).

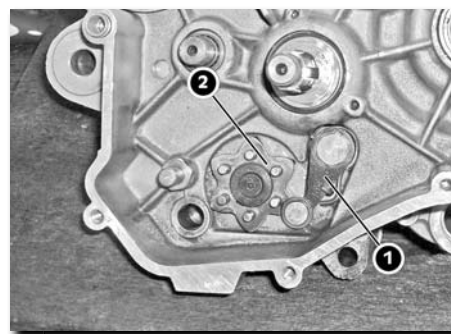

- Heat up the crankcase unit around the bases of the primary and secondary crankshaft bearings, on both sides (to approximately 60°C).

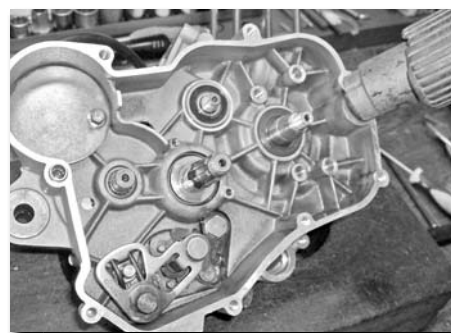

DISMANTLING/REASSEMBLING THE CRANKSHAFT AND GEAR CHANGE

- Rest the crankcase right side (primary transmission side) down on a wooden block. Fit tool number 6 to the left hand side of the crankcase and on the threads fitted for this purpose, and with its central acting shaft on the crankshaft, proceed with the separating of the crankcases. Do not use levers on the crankcase mating surfaces (if these become damaged, they will need to be replaced).

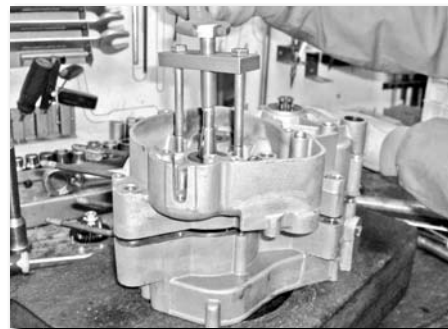

- Now fit tool number 6 onto the threads fitted next to the crankshaft on the right hand crankcase, and extract the crankshaft.

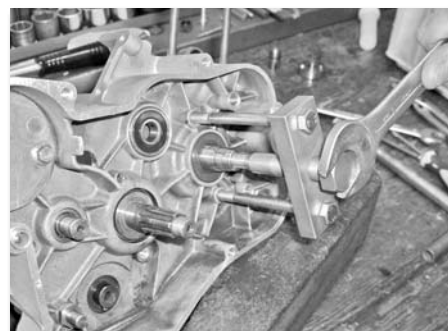

- Pre-heat the crankshaft bearing support base on the crankcase (to approximately 60°C).

- Extract the selector fork guide shafts together with the selector drum and the forks themselves.

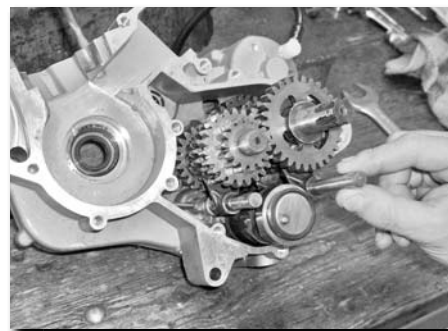

- Extract the gear-change assembly in a single operation, by accessing its two shafts.

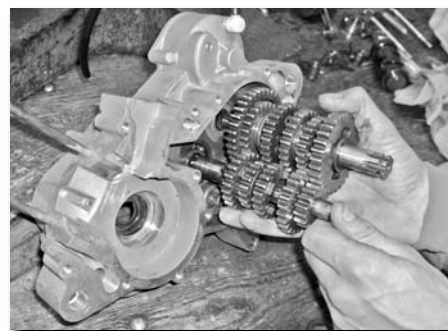

DISMANTLING/REASSEMBLING THE CRANKSHAFT AND GEAR CHANGE

- Clean and completely degrease the crankshaft assembly, and then examine it carefully.

- With the aid of thickness callipers, check the side play of the connecting rod at its connection to the crankshaft crank.

Service limit:
0,8 mm.



-With the aid of a comparison meter, determine the radial clearance of the connecting rod big end bearing in directions X and Y.

Service limit:
0,04 mm.

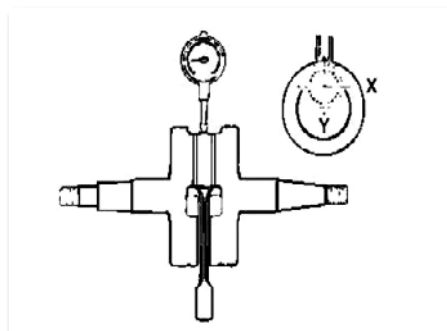

- Renew the connecting rod and its bearings if the service limit is exceeded.

- Fit the crankshaft onto a lathe and turn it, checking the gap between its crank blades with the aid of a pair of comparison meters placed perpendicularly to the circumference of the support shafts (check that there is no burring or grooving).

Service limit:
0,05 mm.



DISMANTLING/REASSEMBLING THE CRANKSHAFT AND GEAR CHANGE

- Clean and lubricate the bearings and check that they turn smoothly, without slackness or grating. If this is not the case, renew them in pairs.



DISMANTLING/REASSEMBLING THE CRANKSHAFT AND GEAR CHANGE

- In order to extract damaged bearings, use a specific extractor, preheating the crankcase (to approximately 90°C). Never refit dismantled bearings, as these become damaged during the extraction operation.



- To fit new bearings, preheat the crankcase (to approximately 90°C), and use a bearing that has just been removed from a freezer. This will allow the bearing to be easily fitted without the need for hardly any pushing. If necessary however, the bearing can be pushed into place.



- Clean and completely degrease the gear change assembly, and then examine it carefully.

- Make a visual examination of the gear change gearing teeth. If there are thermal fatigue marks (discoloration), loss of surface hardness covering, or uneven wear to the teeth (points), replace the damaged components. In the case of the primary assembly, it should be changed complete.



DISMANTLING/REASSEMBLING THE CRANKSHAFT AND GEAR CHANGE

- Continue with the complete dismantling of the secondary assembly, extracting the assembly's locking circlip and then dismantling the assembly completely in order (have a clean cloth ready on which to lay out the parts as they are detached).



- Check that there is no burring and/or uneven wear to the nipples and the mounting holes of the movable gearing speed setting system, nor to its knurlings.



- Check the degree of wear on the secondary free gears turning bushes.

- If they are damaged on 25% or more of their surface area, renew them. At the same time renew the assembly's fixed position circlips.



DISMANTLING/REASSEMBLING THE CRANKSHAFT AND GEAR CHANGE

- Check the secondary shaft gear needle bearings in turn. If they are damaged, renew them.



- Clean all the components of the gear change assembly and selector, as well as the crankshaft, with degreaser.

- Refit the secondary gear change assembly, taking great care to ensure that all its components are reassembled correctly, to prevent the assembly from malfunctioning and jamming.

Shaft right hand part:

1. Secondary shaft.
2. 4th secondary pinion (z 24).
3. 3rd secondary pinion (z 27).
4. 23.3x16x1 toothed washer.
5. Pinion segment ring.
6. 5th movable pinion (z 23).
7. 25 x14.2x1 washer.
8. 14x18x8 needle housing ring.
9. 1st secondary pinion (z 34).
10. 28x14.2x1.85 friction washer.

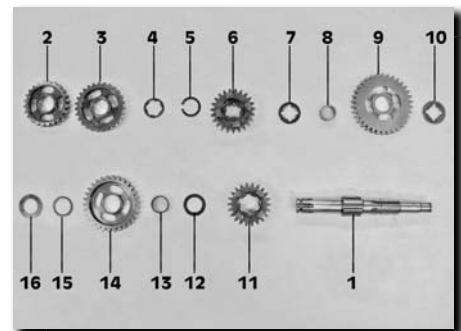

Left hand shaft part:

11. 6th movable pinion (z 22).
12. 25 x17.2x1 washer.
13. 2nd secondary pinion bush.
14. 2nd pinion (z 30).
15. 23.5 x18.2x1 washer.
16. 28 x17.1x1.2 washer.

DISMANTLING/REASSEMBLING THE CRANKSHAFT AND GEAR CHANGE

- Fit the gear change assembly on to the right hand crankcase (insert the first and secondary assemblies together, interlocked).

- Check previously the total thickness of the secondary gear change shaft including its adjusting washers on both sides.

Total secondary thickness:
MAX 87,700 mm.
MIN 87,350 mm.

(different thicknesses of washer are available to enable the correct adjustment to be achieved).

- Next, fit the selector forks, selector drum and its washers, as well as the selector fork shafts. Lubricate the surfaces with SAE 10W40API:GL-4 oil.

- Check the correct action of the gear change by selecting the different speeds and turning the selector drum in both directions. If it jams, recheck the correct fitting. Leave it selected in neutral and check the free turning of the assembly's elements.

- Fit the crankshaft into the right hand crankcase.

- Fit a new crankcase joining gasket, paying attention to the free section in the inlet area.

- Heat up the left hand crankcase (approximately 60°C), and fit it into position closing with the right hand crankcase. Fit the assembly securing bolts, having first cleaned these scrupulously. Crankcase bolts tightening torque: 6N.m (0.8 – 1.0 m.kg)

- Ensure that the crankshaft, the primary shaft and the secondary shaft turn freely (in neutral).

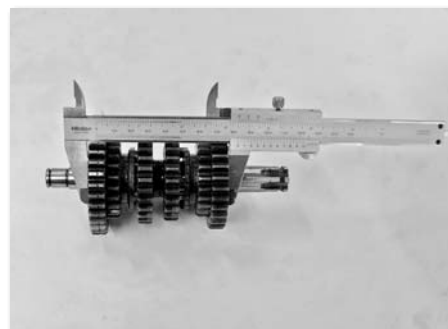
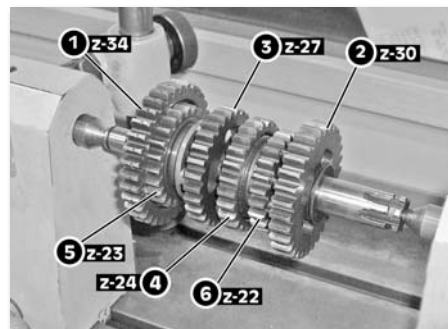

DISMANTLING/REASSEMBLING THE CRANKSHAFT AND GEAR CHANGE

- If the crankshaft fails to turn, this probably indicates that the crankshaft is not centred. Tap the appropriate end of the crankshaft lightly with a rubber mallet to return it to its correct position.
- Turn the secondary shaft and select all the gears to ensure that there is no tightness and that all the gears change correctly.
- Check the axial play of the secondary gear change shaft. It should be between 0.2 and 0.4 mm.
- With the aid of a specific fitting device (tools number 1 and 18), fit new crankshaft oil seals, after first applying a film of API:TC synthetic 2-stroke oil to the sealing edges.
- Refit the primary transmission assembly.
- Refit the magneto ignition assembly.
- Refit the cylinder, piston and cylinder head assembly.
- Refill and bleed the engine cooling system and separate lubrication system.
- Refill the clutch assembly/gear change crankcase with oil.
- Start up the engine and make a quick test of gear change and clutch function.

DISMANTLING THE ALTERNATOR MAGNETO

DISMANTLING THE ALTERNATOR MAGNETO

- Remove the gear change lever and the alternator magneto closing cover on the left hand side of the engine.



- Use tool number 9 to lock the magneto flywheel and then loosen the nut securing the magneto to the crankshaft.

- Insert tool number 8 and extract the magneto flywheel.



- Extract the stator coil assembly by loosening and extracting the bolts that secure it to its support. Finally extract the support plate bolted to the crankcase.

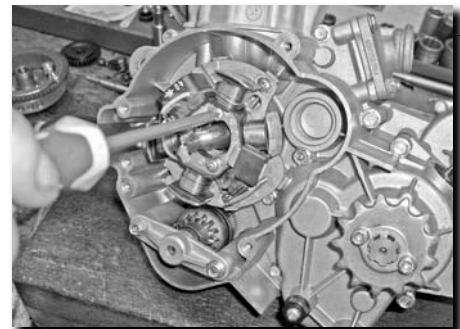

- Disconnect the alternator magneto connector.

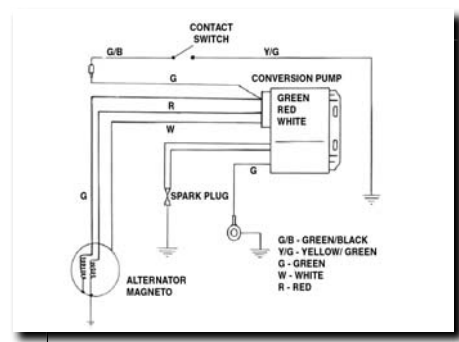

DISMANTLING THE ALTERNATOR MAGNETO

- Carry out a static check of the unit as outlined below, with the aid of a multi-meter set to measure circuit/resistance (ohms: Ω), and selecting the appropriate scale depending on the level to be measured.

Checking the wiring coil:

CABLE COLOUR	YELLOW
WHITE	$0.3 \div 0.9 \Omega \pm 10\%$



- Checking the alternator magneto supply coil:

CABLE COLOUR	GREEN
EARTH	$610 \Omega \pm 10\%$

- Checking the pick-up:

CABLE COLOUR	RED
EARTH	$80 \Omega \pm 10\%$

- Checking the HT coil secondary circuit (without spark plug connector cap):

CABLE COLOUR	THICK BLACK
EARTH	$3.4 \text{ k}\Omega \pm 15\%$



- Checking the spark plug connector cap: Disconnect it from its joint with the secondary cable and measure its resistance value between the two ends of the connection. This should be $5.0 \text{ k}\Omega \pm 15\%$.

DISMANTLING THE ALTERNATOR MAGNETO

- Should a fault occur, renew the whole component where a problem has been found after inspecting up to this point.

- Proceed with refitting the unit, paying special attention to the condition of the key on the end of the crankshaft. Renew it if any damage is observed.



- In order to properly synchronise the ignition point, when refitting the coil holding plate onto the engine crankcase, make sure to line up the mark on the plate with the centre of the arrow on the crankcase.

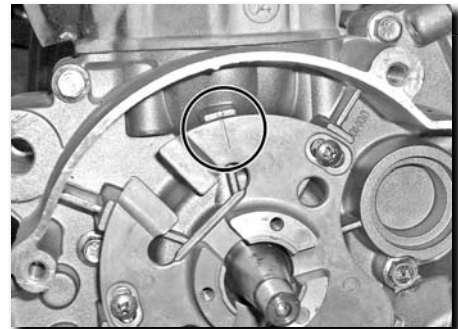

- Refit the alternator magneto coil assembly onto the coil holding plate, refit the magneto flywheel (check that the inner magnet is free of breakages or imperfections – renew it if this is not the case), with the help of tool number 9 to stop it from turning.



- Apply the corresponding tightening torque. The ignition timing setting requires no maintenance. Make sure that the unit's electrical wiring run is correct, to prevent it rubbing up against the magneto, as this could cause damage to the wires and lead to subsequent faults.



NACIONAL MOTOR, S.A.U.
E-08107 MARTORELLES
T (+34) 93 565 78 78
WWW.DERBI.COM

DERBI POST-VENTA
AFTER-SALES

 use recambios
ORIGINALES
use original parts

D GARANTIA
WARRANTY
OK